

YDS-N8MA-IMX214 V1.2

13MP Sony IMX214 MIPI-Schnittstellen-Autofokus-Kameramodul

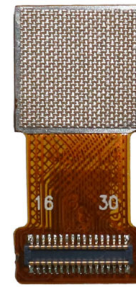

Vorderansicht



Rückansicht

Spezifikationen

| | |
|---------------------------------|-------------------------------------|
| Kameramodul Nr. | YDS-N8MA-IMX214 V1.2 |
| Auflösung | 13MP |
| Bildsensor | IMX214 |
| Sensorart | 1/3.06" |
| Pixel Größe | 1.12 um x 1.12 um |
| EFL | 3.57 mm |
| F.NO | 2.00 |
| Pixel | 4224 x 3136 |
| Betrachtungswinkel | 78.4°(DFOV) 66.2°(HFOV) 51.6°(VFOV) |
| Linsenabmessungen | 8.50 x 8.50 x 5.26 mm |
| Modulgröße | 19.05 x 9.00 mm |
| Modultyp | Autofokus |
| Schnittstelle | MIPI |
| Autofokus-VCM-Treiber-IC | FP5510 |
| Objektivtyp | 650 nm IR-Schnitt |
| Betriebstemperatur | -20°C to +70°C |
| Gegenstecker | WP7A-S030VA1 |

YDS-N8MA-IMX214 V1.2

13MP Sony IMX214 MIPI-Schnittstellen-Autofokus-Kameramodul

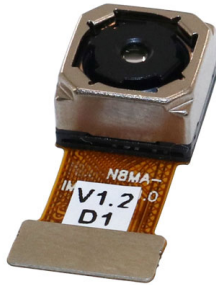

Ansicht von oben



Seitenansicht

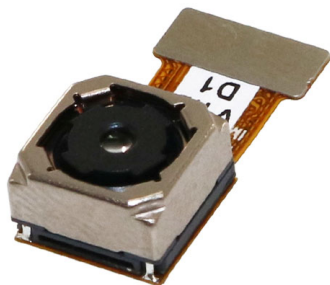

Untersicht

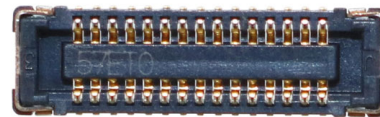

Gegenstecker

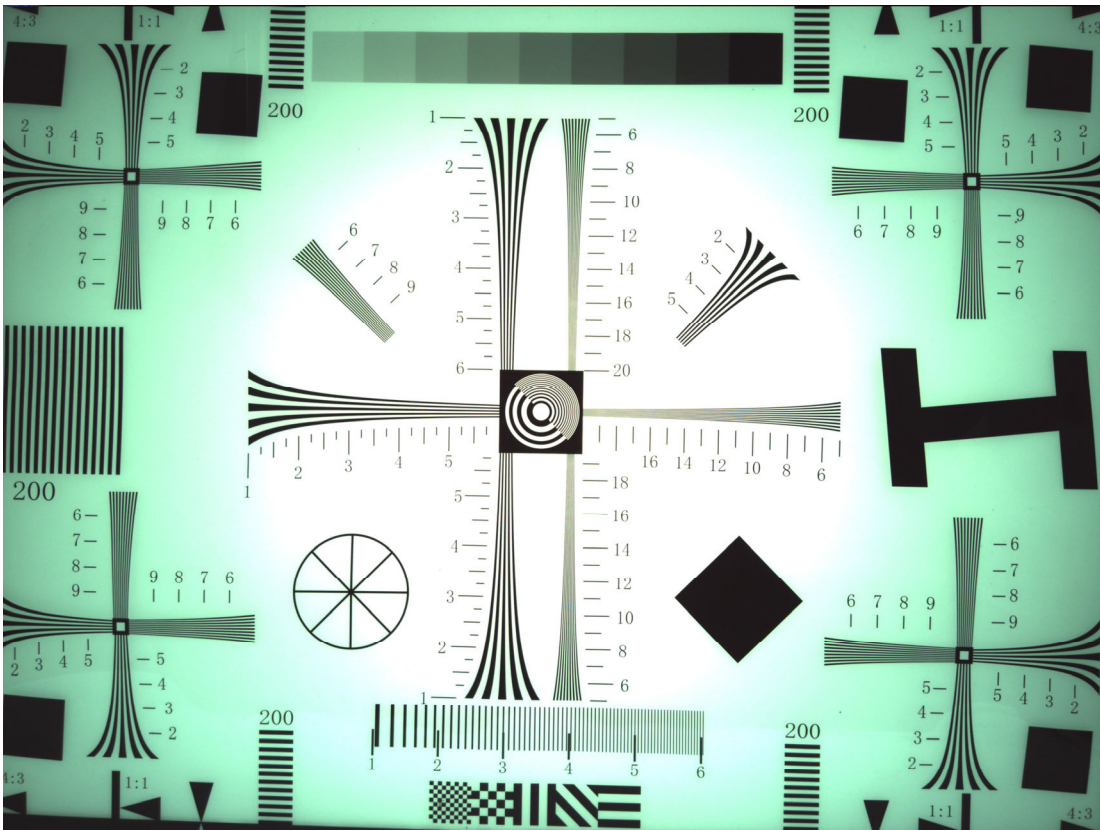

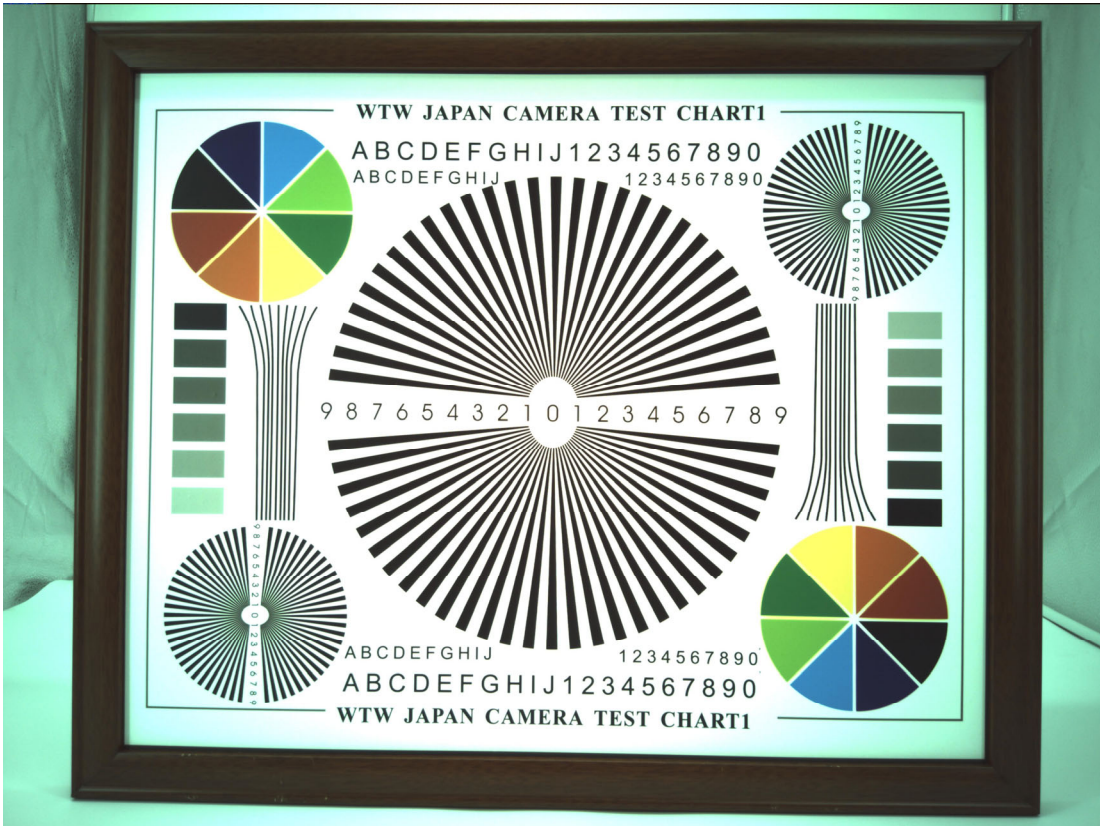

| RoHS | |
|------|------------|
| PIN | SIGNAL |
| 1 | MCLK |
| 2 | DGND |
| 3 | MDP0 |
| 4 | MDN0 |
| 5 | DGND |
| 6 | MDN1 |
| 7 | MDP1 |
| 8 | DGND |
| 9 | MCN |
| 10 | MCP |
| 11 | DGND |
| 12 | AF_VDD2.8V |
| 13 | AF-GND |
| 14 | AVDD2.8V |
| 15 | AGND |
| 16 | DVDD1.0V |
| 17 | DOVDD1.8V |
| 18 | DGND |
| 19 | SCL |
| 20 | SDA |
| 21 | RESET |
| 22 | NC |
| 23 | NC |
| 24 | DGND |
| 25 | MDP3 |
| 26 | MDN3 |
| 27 | DGND |
| 28 | MDN2 |
| 29 | MDP2 |
| 30 | DGND |

| Version | Information | Date |
|---------|---------------|------------|
| V1.0 | First Version | 5-4-2018 |
| V1.2 | Change VCM | 12-19-2022 |

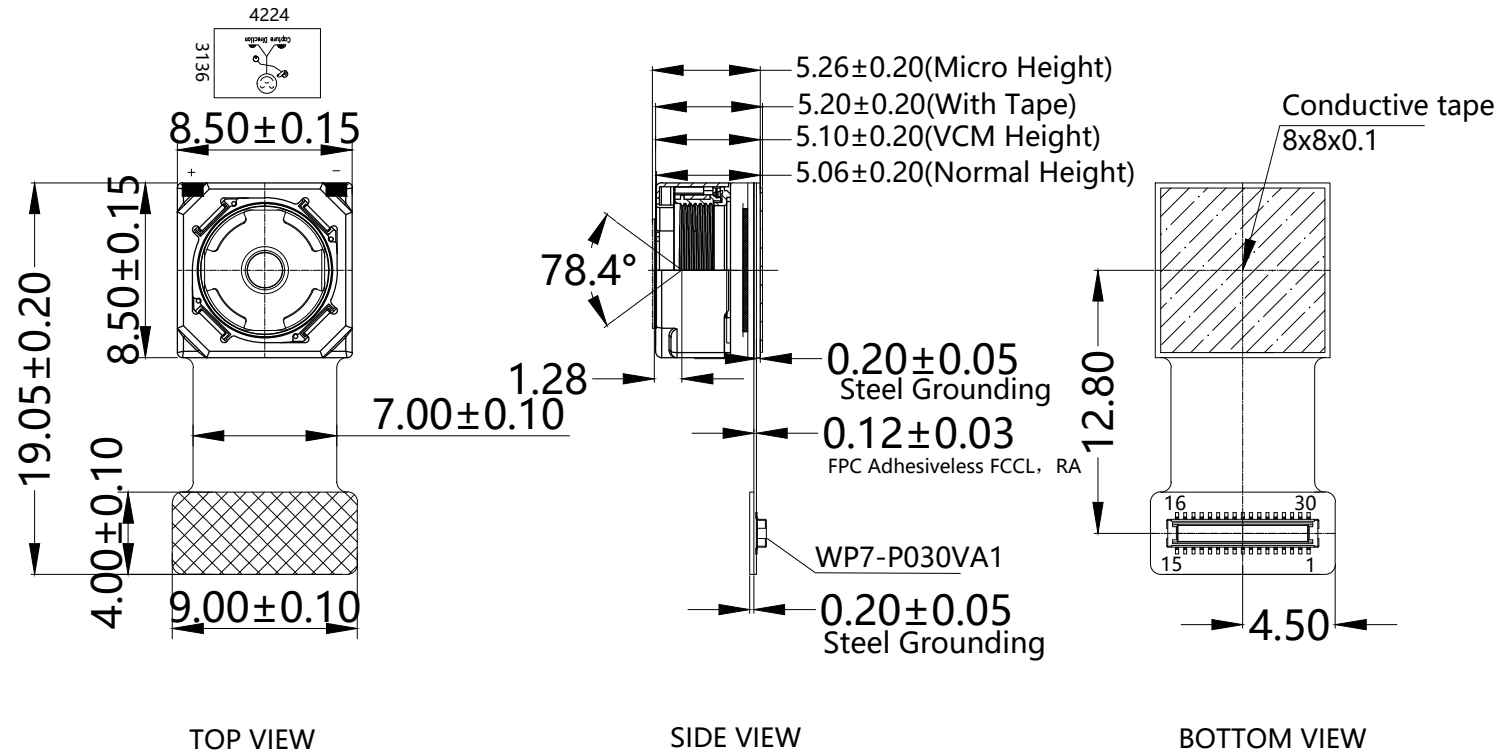

NOTE:
1.The device slave address:0x20;

Parameters:

1、 Sensor specification:

Image Sensor: IMX214
Pixel: 1.12um*1.12um
Lens Type: 1/3.06
Important Voltage Description:
DVDD1.0V (external power supply);

2、 Lens specification:

FOV: 78.4°(D);66.2°(H);51.6°(V);
F/NO.: 2.0
TV distortion: <1.5%
Focal length: 3.57mm
Composition: 5P+IR FILTER
IR Cut Coating: 650nm±10nm@50%

| | | | | | |
|-------------|-----------|------------------|------------------|-----------|--|
| Designed By | Kevin | Model Name: | N8MA-IMX214 V1.2 | | |
| Checked By | Aouly_Yan | Projection Type: | Unit: | Material: | |
| | | | mm | ----- | |
| | | Scale: | Sheet: | Version: | |
| | | 1:1 | 1 of 1 | 1/0 | |

[Product Brief]

Ver.1.0

IMX214

Diagonal 5.867mm (Type 1/3.06) 13M Pixel CMOS Image Sensor with Square Pixel for Color Cameras

Description

IMX214 is a diagonal 5.867mm(Type 1/3.06) 13M pixel CMOS active pixel type stacked image sensor with a square pixel array. It adopts Exmor RS™ technology to achieve high speed image capturing by column parallel A/D converter circuits and high sensitivity and low noise image (comparing with conventional CMOS image sensor) through the backside illuminated imaging pixel structure. R, G, and B pigment primary color mosaic filter is employed. By introducing spacially varying exposure technology, high dynamic range still pictures and movies are achievable. It equips an electronic shutter with variable integration time. It operates with three power supply voltages: analog 2.7 V, digital 1.0V and 1.8 V for input/output interface and achieves low power consumption. IMX214 is designed for use in cellular phones or tablet devices*.

Functions and Features

- ◆ Back illuminated and stacked CMOS image sensor Exmor RS
- ◆ Single Frame High Dynamic Range (HDR) with equivalent full pixels.
- ◆ High signal to noise ratio (SNR).
- ◆ Full resolution @30fps (Normal / HDR).4K2K @30fps (Normal / HDR)1080p @60fps (Normal / HDR)
- ◆ Output video format of RAW10/8, COMP8/6
- ◆ Pixel binning readout and H/V sub sampling function
- ◆ Advanced Noise Reduction (Chroma noise reduction and luminance noise reduction)
- ◆ Independent flipping and mirroring.
- ◆ CSI 2 serial data output (MIPI 2lane/4lane, Max. 1.2Gbps/lane, DPHY spec. ver. 1.1 compliant)
- ◆ 2wire serial communication
- ◆ Two PLLs for independent clock generation for pixel control and data output interface.
- ◆ Advanced Noise Reduction.
- ◆ Dynamic Defect Pixel Correction.
- ◆ Zero shutter lag.
- ◆ Power on reset function
- ◆ Dual sensor synchronization operation.
- ◆ 8K bit of OTP ROM for users.
- ◆ Built in temperature sensor

NOTE)

1. When using this product for another application, Sony does not guarantee the quality and reliability of product. Therefore, don't use this for applications other than cellular phone and Tablet PCs. Consult your Sony sales representative if you have any questions.

Device Structure

- ◆ CMOS image sensor
- ◆ Image size : Diagonal 5.867mm (Type 1/3.06)
- ◆ Total number of pixels : 4224 (H) × 3200(V) approx. 13.51M pixels
- ◆ Number of effective pixels : 4224 (H) × 3136 (V) approx. 13.25 M pixels
- ◆ Number of active pixels : 4208 (H) × 3120 (V) approx. 13.13 M pixels
- ◆ Chip size : 6.100mm (H) × 4.524mm (V)
- ◆ Unit cell size : 1.12 μm (H) × 1.12 μm (V)
- ◆ Substrate material : Silicon

Functional Description

System Outline

IMX214 is a CMOS active pixel type image sensor which adopts the Exmor RS™ technology to achieve high sensitivity, low noise and high speed image capturing. It is embedded with backside illuminated imaging pixel, low noise analog amplifier, column parallel A/D converters which enables high speed capturing, digital amplifier, image binning circuit, timing control circuit for imaging size and frame rate, CSI2 image data high speed serial interface, PLL oscillator, and serial communication interface to control these functions. Several additional image processing functions and peripheral circuits are also included for easy system optimization by the users. A one time programmable memory is embedded in the chip for storing the user data. It has 8 K-bit for users, 10 K-bit as a whole.

Block Diagram

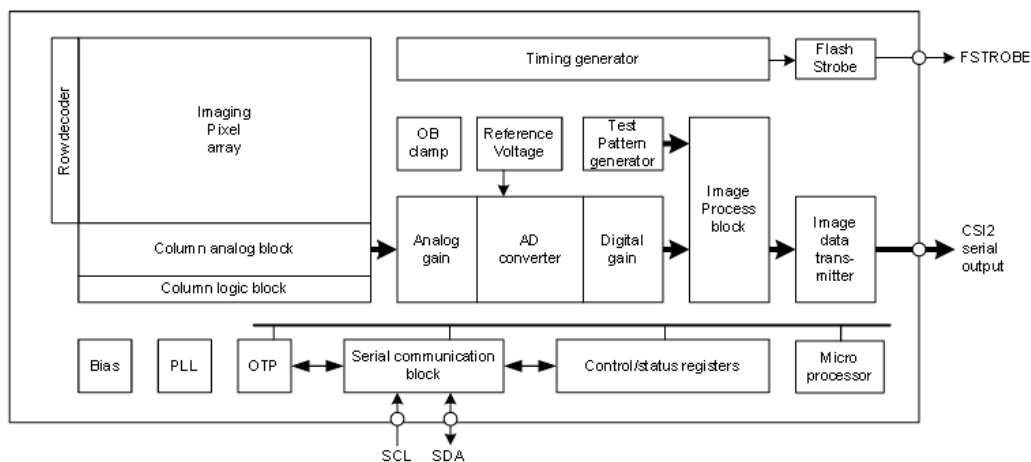

* Exmor RS is a trademark of Sony Corporation. The Exmor RS is a Sony's CMOS image sensor with high-resolution, high-performance and compact size by replacing a supporting substrate in Exmor R™ which changed fundamental structure of Exmor™ pixel adopted column parallel A/D converter to back-illuminated type, with layered chips formed signal processing circuits.

Sony reserves the right to change products and specifications without prior notice.

This information does not convey any license by any implication or otherwise under any patents or other right.

Application circuits shown, if any, are typical examples illustrating the operation of the devices. Sony cannot assume responsibility for any problems arising out of the use of these circuits.

10-Bit DAC 120mA VCM Driver with I²C Interface

Description

The FP5510 is a single 10-bit DAC with 120mA output current voice coil motor (VCM) driver, with an I²C-compatible serial interface that operates at clock rates up to 400kHz. Its supply operates from 2.3V to 3.6V.

The FP5510 incorporates with a power-on reset circuit, power-down function. Power-on reset circuit ensure when supply power up, DAC output is to 0V until valid write bit value takes place. In power down mode, the supply current is about 1µA.

The FP5510 is designed for auto focus operation includes digital camera module, optical zoom camera phones and lens auto focus. The I²C address of FP5510 is 0x18h.

The FP5510 with WLCSP package which it is suitable for reduced-space mounting in mobile phone and other portable applications.

Pin Assignments

6-Ball WLCSP

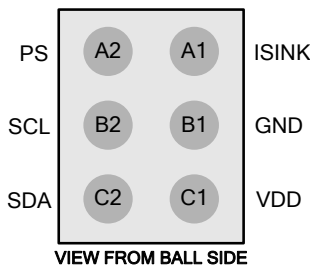

Figure 1. Pin Assignment of FP5510

Features

- Power Supply Voltage Rang: 2.3V to 3.6V
- VCM Driver for Auto-Focus
- 10-Bit Resolution Current Sinking of 120mA for VCM
- 2-Wire I²C Interface (1.8V Interface Compatible)
- Internal 4 Slope Control Mechanism
 1. Enhance Slope Control Mode
 2. One Step Mode
 3. Linear Slope Mode
 4. Two Step Slope Mode
- Power-Save Mode Current < 1µA
- Power On Reset (POR)
- Small Size: 0.7mm×1.1mm (6-Balls WLCSP)

Applications

- Digital Camera Module
- Cell Phone
- Lens Cover
- Web Camera

Ordering Information

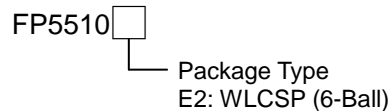

WLCSP-6 (0.7mm×1.1mm) Marking

| Part Number | Product Code |
|-------------|--------------|
| FP5510E2 | 2 |

NEW



0.4mm Pitch, Stacking Type
Board-to-Board (FPC) Connector

CONNECTOR

MB-0228-3

September 2017

WP7 Series

RoHS Compliant

Plug

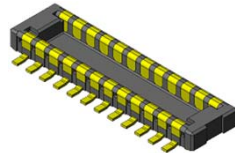

Plug

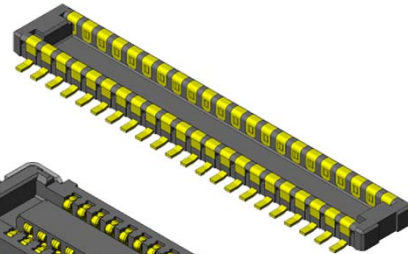

Receptacle

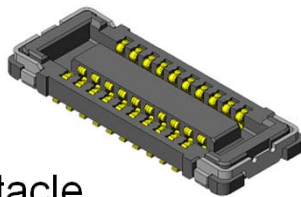

Receptacle

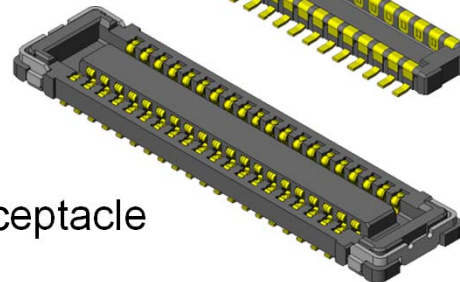

The WP7 Series is a low-profile board-to-board (FPC) connector with 0.4mm pitch spacing that is ideal for high-density mounting in slim information communication devices like mobile phones, smartphones, LCD, and notebook PC.

To satisfy different product function requirements, a low pin count type and a high pin count type (WP7A / WP7B) are available with the same mounting pattern.

Features

- 0.4mm pitch, 2 rows, 0.7mm stacking height.
- Contact structure ensures high wear-resistance and high contact reliability.
- Secure hold-downs prevent insulator breakage and peeling from FPC.
- 2-point contact design to resist twisting stress.
- Pb-free (Ni barrier on contact prevents solder wicking.)
- Receptacle contacts adopt an optimal configuration according to the pin counts.
High removal force WP7A (low pin count: 10-32 pos.)
Low insertion force WP7B (high pin count 34-70 pos.)
- Signal contact supports 10 Gbps transmission rate.
- Supports MIPI, USB3.1 Gen2, and PCIe Gen3 transmission.

General Specifications

- | | |
|---|---|
| <ul style="list-style-type: none"> ■(WP7A) No. of Contacts: 10, 16, 20, 22, 24, 26, 28, 30, 32 pos. ■(WP7B) No. of Contacts: 34, 40, 50, 60, 70 pos. ■Pitch: 0.4mm, 2 rows ■Operating Temperature: -40 Deg. C to +85 Deg. C ■Contact Resistance: 70mΩ max. (initial) ■Life Time: 30 mating cycles | <ul style="list-style-type: none"> ■Rated Current: AC, DC 0.3A each per terminal ■Rated Voltage: AC, DC 50V ■Insulation Resistance: 100MΩ min. (initial) ■Dielectric Withstanding Voltage: AC250Vr.m.s for 1 minute ■(WP7A) total insertion force: 1.50N x n max. (n: No. of pos.) ■(WP7A) total removal force: 0.15N x n min. (n: No. of pos.) ■(WP7B) total insertion force: 1.00N x n max. (n: No. of pos.) ■(WP7B) total removal force: 0.10N x n min. (n: No. of pos.) |
|---|---|

| | |
|-------------|--------------|
| Part Number | WP7A-S***VA1 |
| SJ Drawing | SJ111877 |

WP7A Receptacle

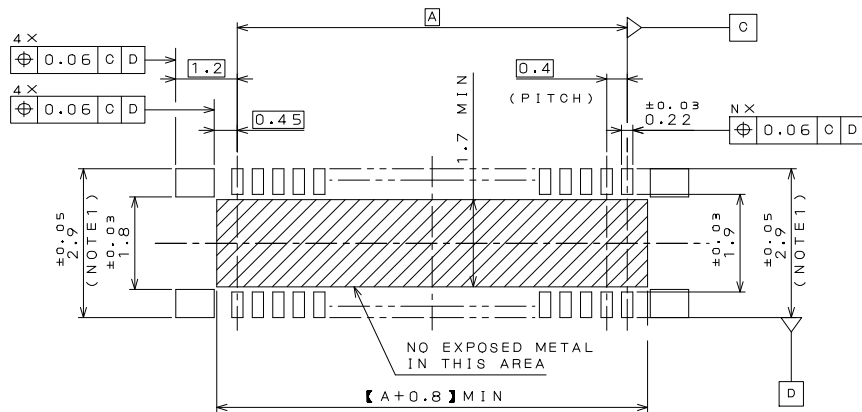
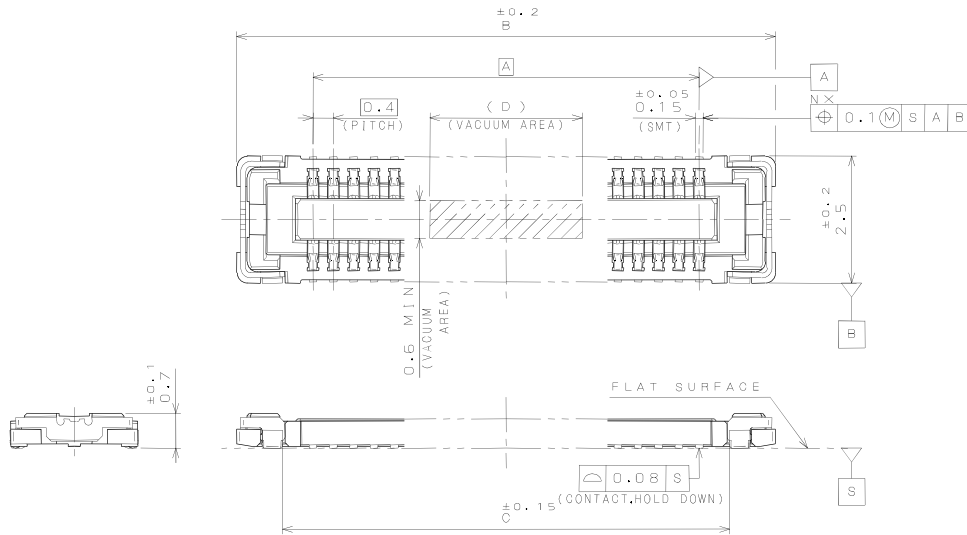

APPLICABLE P.C.B. DIMENSION (REF.)
適合基板寸法 (参考)

| DIMENSIONS 寸法 NUMBER OF CONTACT 芯数 | DIMENSIONS | | | |
|--|------------|-----|-----|-----|
| | A | B | C | D |
| 10 | 1.6 | 4.6 | 2.8 | 2.0 |
| 16 | 2.8 | 5.8 | 4.0 | 2.0 |
| 20 | 3.6 | 6.6 | 4.8 | 2.0 |
| 22 | 4.0 | 7.0 | 5.2 | 2.0 |
| 24 | 4.4 | 7.4 | 5.6 | 2.0 |
| 26 | 4.8 | 7.8 | 6.0 | 5.0 |
| 28 | 5.2 | 8.2 | 6.4 | 5.0 |
| 30 | 5.6 | 8.6 | 6.8 | 5.0 |
| 32 | 6.0 | 9.0 | 7.2 | 5.0 |

Note 1) Dimension 3.5 ± 0.05 is recommended in case repair is needed.

Kameraanwendungen



Autopilot



Live-Streaming



Videokonferenz



Biometrische Eye-Tracker-Erkennung

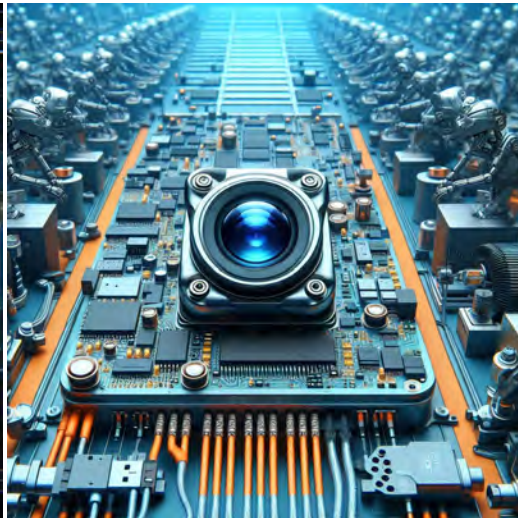

Maschinelles Sehen



Agrarmonitor



Nachtsichtsicherheit



Drohnen- und Sport-Adleraugen



Interaktive Haustierkamera

Referenztable für die Pinbelegungsdefinition des Kameramoduls

| OmniVision Sony Himax Samsung On-Semi Aptina Himax GalaxyCore PixArt Bildsensoren | |
|---|---|
| Pin Signal | Beschreibung |
| DGND GND | Masse für digitale Schaltung |
| AGND | Masse für analoge Schaltung |
| PCLK DCK | DVP-PCLK-Ausgang |
| XCLR PWDN XSHUTDOWN STANDBY | Abschalten aktiv hoch mit internem Pulldown-Widerstand |
| MCLK XVCLK XCLK INCK | Systemeingangsuhr |
| RESET RST | Aktiv Low mit internem Pull-up-Widerstand zurücksetzen |
| NC NULL | keine Verbindung |
| SDA SIO_D SIOD | SCCB-Daten |
| SCL SIO_C SOIC | SCCB-Eingangstakt |
| VSYNC XVS FSYNC | DVP-VSYNC-Ausgang |
| HREF XHS | DVP-HREF-Ausgang |
| DOVDD | Strom für E/A-Schaltung |
| AFVDD | Strom für VCM-Schaltung |
| AVDD | Strom für analoge Schaltung |
| DVDD | Strom für digitale Schaltung |
| STROBE FSTROBE | Strobe-Ausgang |
| FSIN | Synchronisieren Sie das VSYNC-Signal vom anderen Sensor |
| SID | SCCB letzte Bit-ID-Eingabe |
| ILPWM | mechanische Shutter-Ausgangsanzeige |
| FREX | Rahmenbelichtung / mechanischer Verschluss |
| GPIO | Allzweckeingänge |
| SLASEL | I2C-Slave-Adresse auswählen |
| AFEN | CEN-Chip aktivieren aktiv hoch auf VCM-Treiber-IC |
| MIPI Schnittstelle | |
| MDN0 DN0 MD0N DATA_N DMO1N | MIPI 1st negative Ausgabe der Datenspur |
| MDP0 DP0 MD0P DATA_P DMO1P | MIPI 1st positiver Ausgang der Datenspur |
| MDN1 DN1 MD1N DATA2_N DMO2N | MIPI 2nd negative Ausgabe der Datenspur |
| MDP1 DP1 MD1P DATA2_P DMO2P | MIPI 2nd positiver Ausgang der Datenspur |
| MDN2 DN2 MD2N DATA3_N DMO3N | MIPI 3rd negative Ausgabe der Datenspur |
| MDP2 DP2 MD2P DATA3_P DMO3P | MIPI 3rd positiver Ausgang der Datenspur |
| MDN3 DN3 MD3N DATA4_N DMO4N | MIPI 4th negative Ausgabe der Datenspur |
| MDP3 DP3 MD3P DATA4_P DMO4P | MIPI 4th positiver Ausgang der Datenspur |
| MCN CLKN CLK_N DCKN | MIPI Uhr negativer Ausgang |
| MCP CLKP MCP CLK_P DCKN | MIPI Takt positiver Ausgang |
| DVP Parallel Schnittstelle | |
| D0 DO0 Y0 | DVP Datenausgabeport 0 |
| D1 DO1 Y1 | DVP Datenausgabeport 1 |
| D2 DO2 Y2 | DVP Datenausgabeport 2 |
| D3 DO3 Y3 | DVP Datenausgabeport 3 |
| D4 DO4 Y4 | DVP Datenausgabeport 4 |
| D5 DO5 Y5 | DVP Datenausgabeport 5 |
| D6 DO6 Y6 | DVP Datenausgabeport 6 |
| D7 DO7 Y7 | DVP Datenausgabeport 7 |
| D8 DO8 Y8 | DVP Datenausgabeport 8 |
| D9 DO9 Y9 | DVP Datenausgabeport 9 |
| D10 DO10 Y10 | DVP Datenausgabeport 10 |
| D11 DO11 Y11 | DVP Datenausgabeport 11 |

Kamera-Zuverlässigkeitstest

| Zuverlässigkeitsprüfpunkt | | Testmethode | Akzeptanzkriterium | |
|---------------------------|------------------------------------|---|---------------------------|---------------------------|
| Kategorie | Artikel | | | |
| Umwelt | Lager Temperatur | Hoch 60°C 96 Std | Temperaturkammer | Keine anormale Situation |
| | | Niedrig -20°C 96 Std | Temperaturkammer | Keine anormale Situation |
| | Betriebs Temperatur | Hoch 60°C 24 Std | Temperaturkammer | Keine anormale Situation |
| | | Niedrig -20°C 24 Std | Temperaturkammer | Keine anormale Situation |
| | Feuchtigkeit | 60°C 80% 24 Std | Temperaturkammer | Keine anormale Situation |
| | Thermischer Schock | Hoch 60°C 0.5 Std Niedrig -20°C 0.5 Std Radfahren rein 24 Std | Temperaturkammer | Keine anormale Situation |
| Physisch | Falltest (Im freien Fall) | Ohne Verpackung 60cm | 10 Mal auf Holzboden | Elektrisch funktionsfähig |
| | | Mit Paket 60cm | 10 Mal auf Holzboden | Elektrisch funktionsfähig |
| | Vibrations Test | 50Hz X-Axis 2mm 30 Minuten | Vibrationstisch | Elektrisch funktionsfähig |
| | | 50Hz Y-Axis 2mm 30 Minuten | Vibrationstisch | Elektrisch funktionsfähig |
| | | 50Hz Z-Axis 2mm 30 Minuten | Vibrationstisch | Elektrisch funktionsfähig |
| | Zugfestigkeit des Kabels Krafttest | Gewicht laden 4 kg 60 Sekunden Radfahren rein 24 Std | Zugprüfmaschine | Elektrisch funktionsfähig |
| Elektrisch | ESD-Test | Kontaktaufnahme 2 KV | ESD-Prüfmaschine | Elektrisch funktionsfähig |
| | | Luftentladung 4 KV | ESD-Prüfmaschine | Elektrisch funktionsfähig |
| | Alterungstest | On/Off 30 Sekunden Radfahren rein 24 Std | Stromschalter | Elektrisch funktionsfähig |
| | USB-Anschluss | On/Off 250 Mal | Einstecken und ausstecken | Elektrisch funktionsfähig |



Kamerainspektionsstandard

| Inspektionsgegenstand | | Untersuchungsmethode | Inspektionsstandard | |
|-----------------------|--------------|--------------------------|------------------------------|---|
| Kategorie | Artikel | | | |
| Aussehen | FPC oder PCB | Farbe | Das bloße Auge | Größere Unterschiede sind nicht zulässig. |
| | | Zerrissen/gehackt werden | Das bloße Auge | Das Freilegen von Kupferrissen ist nicht zulässig. |
| | | Markierung | Das bloße Auge | Klar, erkennbar (innerhalb von 30 cm Entfernung) |
| | Halterin | Kratzer | Das bloße Auge | Die Freilegung von Rissen im Inneren ist nicht zulässig |
| | | Lücke | Das bloße Auge | Erfüllen Sie den Höhenstandard |
| | | Schraube | Das bloße Auge | Stellen Sie sicher, dass Schrauben vorhanden sind (falls vorhanden) |
| | | Schaden | Das bloße Auge | Die Freilegung von Rissen im Inneren ist nicht zulässig |
| | Linse | Kratzen | Das bloße Auge | Keine Auswirkung auf den Auflösungsstandard |
| | | Kontamination | Das bloße Auge | Keine Auswirkung auf den Auflösungsstandard |
| | | Ölfilm | Das bloße Auge | Keine Auswirkung auf den Auflösungsstandard |
| | | Abdeckband | Das bloße Auge | Kein Problem beim Aussehen. |
| | Funktion | Bild | Keine Kommunikation | Testboard |
| Helles Pixel | | | Tafel | Im Image Center nicht erlaubt |
| Dunkles Pixel | | | Weißer Tafel | Im Image Center nicht erlaubt |
| Verschwommen | | | Das bloße Auge | Nicht erlaubt |
| Kein Bild | | | Das bloße Auge | Nicht erlaubt |
| Vertikale Linie | | | Das bloße Auge | Nicht erlaubt |
| Horizontale Linie | | | Das bloße Auge | Nicht erlaubt |
| Kleines Leck | | | Das bloße Auge | Nicht erlaubt |
| Blinkendes Bild | | | Das bloße Auge | Nicht erlaubt |
| Prellung | | | Inspektionslehre | Nicht erlaubt |
| Auflösung | | | Diagramm | Folgt dem Diagrammstandard für ausgehende Inspektionen |
| Farbe | | | Das bloße Auge | Kein Problem |
| Lärm | | | Das bloße Auge | Nicht erlaubt |
| Ecke dunkel | | | Das bloße Auge | Weniger als 100 x 100 Pixel |
| Farbauflösung | | | Das bloße Auge | Kein Problem |
| Abmessungen | Höhe | Das bloße Auge | Befolgt Zulassungsdatenblatt | |
| | Breite | Das bloße Auge | Befolgt Zulassungsdatenblatt | |
| | Länge | Das bloße Auge | Befolgt Zulassungsdatenblatt | |
| | Gesamt | Das bloße Auge | Befolgt Zulassungsdatenblatt | |

YDSCAM Paketlösungen

YDSCAM Kameramodul



Komplett mit Linsenschutzfolie



Tablett mit Gitter und Raum



Legen Sie die Kameras auf das Tablett



YDSCAM Paketlösungen

Volles Fach mit Kameras



Decken Sie das Tablett mit dem Deckel ab

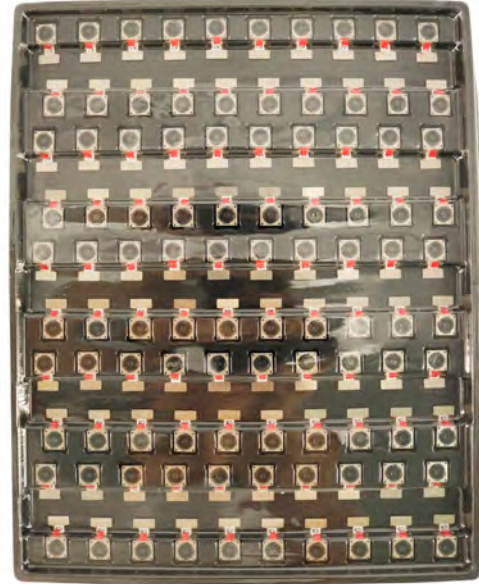

Legen Sie das Tablett in den antistatischen Beutel



Staubsaugen Sie den antistatischen Beutel



YDSCAM Paketlösungen

Versiegelter antistatischer Vakuumbbeutel mit Etiketten

1. Modell und Beschreibung 2. Menge 3. Herstellungsdatumscode 4. Achtung



YDSCAM Paketlösungen

Legen Sie Schaumstoffplatten zwischen die Tablettbeutel



Schaumstoffplatten sind größer als Tablett



Legen Sie Schaumstoffplatten und Tablett in den Karton



Die Schaumstoffplatten sitzen fest im Karton



Verschließen Sie die Carbon Box



Beschriften Sie den Carbon-Versandkarton



YDSCAM Paketlösungen

USB-Kameramodul

Komplett mit Objektivschutzfolie

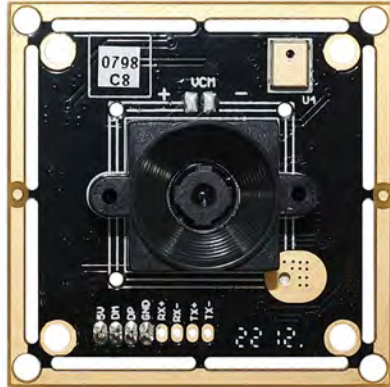

Legen Sie die Kameraprobe in den antistatischen Beutel

Legen Sie USB-Kameras in das Fach



Verschließen Sie das Tablett mit einem antistatischen Beutel

Beschriften Sie den Carbon-Versandkarton



YDSCAM Paketlösungen

Legen Sie die Kameraprobe in den antistatischen Beutel



Legen Sie die Steckverbinder in den antistatischen Beutel



Beschriften Sie die Probenbeutel



Stecken Sie die Steckverbinder in die Spule



Legen Sie Proben in die Carbonbox



Stecken Sie die Steckverbinder in die Carbonbox





Firma YDSCAM

YingDeShun Co. Ltd. (YDS) wurde 2017 gegründet, ein technologieorientierter Hersteller der nächsten Generation, der sich auf Forschung, Design und Produktion von Audio- und Videoprodukten spezialisiert hat. YDS verfügt über 20.000 Quadratmeter große automatisierte Anlagen mit 100 Mitarbeitern und einem Jahresdurchsatz von 30.000.000 Kameraeinheiten.

YDS bietet OEM- und ODM-Design sowie Auftragsfertigung und baut die Kameraprodukte. Sie können uns die Anforderungen mitteilen, sogar mit einem Handentwurf. Unser Vertrieb und unsere Technik arbeiten zusammen, um Ihre Anforderungen zu erfüllen. Wir verstehen uns als Ihr langfristiger Partner bei der Entwicklung praktischer und innovativer Lösungen.

Unser Team deckt alles von der ersten Konzeptentwicklung bis zum Massenprodukt ab. YDS ist auf kundenspezifisches Kameradesign, Rohmaterial, Elektroniktechnik, Firmware-/Softwareentwicklung, Produkttests und Verpackungsdesign spezialisiert. Unsere erfahrenen strategischen Liefersysteme bieten eine robuste und zuverlässige Fertigungskapazität für Aufträge unterschiedlicher Größe.

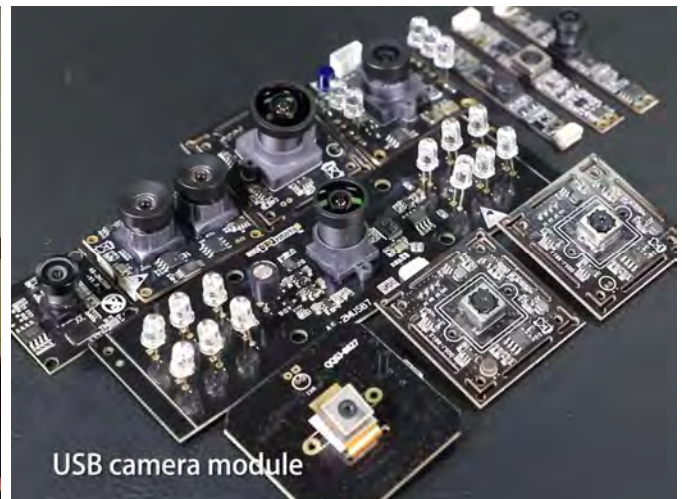

Eingeschränkte Garantie

YDS gewährt die folgende eingeschränkte Garantie, wenn Sie das/die Produkt(e) direkt von der YDS-Firma oder über die YDS-Website www.YDSCAM.com erworben haben. Von anderen Verkäufern oder Quellen gekaufte Produkte fallen nicht unter diese eingeschränkte Garantie. YDS garantiert, dass die Produkte bei normalem Gebrauch für einen Zeitraum von einem (1) Jahr ab dem Datum, an dem Sie das Produkt erhalten („Garanzzeitraum“), frei von Material- und Verarbeitungsfehlern sind.

Für alle Produkte, die während der Garanzzeit wesentliche Material- oder Verarbeitungsfehler aufweisen oder entwickeln, wird YDS nach eigenem Ermessen entweder: (i) das/die Produkt(e) reparieren; (ii) das/die Produkt(e) durch ein/e neue oder generalüberholte(n) Produkt(e) ersetzen (wobei das/die Ersatzprodukt(e) vom identischen Modell oder einer gleichwertigen Funktion sein müssen); oder (iii) Ihnen eine Rückerstattung des Preises gewähren, den Sie für das/die Produkt(e) bezahlt haben.

Diese eingeschränkte Garantie von YDS beschränkt sich ausschließlich auf Reparatur und/oder Ersatz gemäß den oben dargelegten Bedingungen. YDS ist nicht zuverlässig oder verantwortlich für etwaige Folgeereignisse.





YDS CAMERA MODULE

your best camera partner

Unsere Unternehmensstärke

Leistungsstarke Fabrik



Professioneller Service



Versprochene Lieferung



www.YDSCAM.com sales@ydscam.com Phone (WeChat, QQ): (+86) 177 2732 6718

All rights reserved @ YingDeShun Co. Ltd. Specifications subject to change without notice.